

SHARP

ПЕРЕНОСНОЙ СТЕРЕОФОНИЧЕСКИЙ КОМПЛЕКС
PORTABLE HI-FI COMPONENT SYSTEM

WF-939ZP



фирма-изготовитель : ШАРП КОРПОРЕЙШН
фирма-поставщика : ПРОГРЕСС ТРЕЙДИНГ КО., ЛТД.
Токио, Япония

TINSZ0999AFZZ

ИНСТРУКЦИЯ ПО ЭКСПЛУАТАЦИИ
OPERATION MANUAL

ПО-РУССКИ

ENGLISH

INTRODUCTION

Thank you for purchasing this SHARP Product. We hope it will give you many years of trouble-free enjoyment. But for the best performance, read this Manual carefully. It will guide you in operating your SHARP product.

CONTENTS

	Page		Page
SPECIAL NOTES.....	1	RECORDING.....	10-11
CAUTIONS.....	1	• Radio.....	10
NAME OF CONTROLS.....	2-3	• Dubbing.....	10
POWER SOURCE.....	4	• To skip an undesirable programme with APLD and APPS during dubbing.....	11
• AC power.....	4	• Making blank spaces for APLD and APPS.....	11
• Battery power.....	4	• Erasing recorded tapes.....	11
• Car battery power.....	4	• Digital tape counter.....	11
SPEAKERS.....	5	MIXING MICROPHONE.....	11
• Mounting the speakers.....	5	HEADPHONES.....	11
• Removing the speakers.....	5	HOW TO USE THE BUILT-IN TIMER.....	12
SETTING THE CLOCK.....	5	• Listening to the radio, recording radio programmes, playing a tape.....	12
RADIO OPERATION.....	6	• To turn off at a preset time less than 64 minutes.....	12
SOUND CONTROL.....	6	• To turn the radio off with SLEEP and on again with the TIMER.....	12
• Volume.....	6	USE WITH EXTERNAL AUDIO COMPONENTS.....	13
• Graphic equalizer.....	6	• Turntable or compact disc player.....	13
• Spectrum analyzer.....	6	• Using an external amplifier.....	13
CASSETTE OPERATION.....	7	MAINTENANCE.....	14
PLAYBACK.....	8-10	• Internal care.....	14
• Auto reverse.....	8	• External care.....	14
• Continuous playback.....	9	SPECIFICATIONS.....	14
• APLD/APPS/APSS.....	9		
• Cue and review.....	10		

SPECIAL NOTES

Note:

Audio-visual material may consist of copyrighted works which must not be recorded without the authority of the owner of the copyright. Please refer to relevant law in your country.

• The last letter of the model name on the catalogue, packing case, etc. indicates the colour of the product. Operations and Specifications are the same for all units regardless of the cabinet colour.

• Car battery adaptor, microphone, headphones, cotton swab and demagnetiser mentioned in this Operation Manual are not included in this unit.

CAUTIONS

- Do not use oil, solvents, benzene, paint thinner and insecticides on unit.
- Do not expose unit to moisture or temperatures higher than 60°C (140°F).
- Keep unit away from strong magnetism, excessive dust or humidity.
- Hold AC power plug by head when removing from AC outlet, since pulling lead can damage internal strands.

• Remove AC power lead before cleaning internals. Refer all servicing to Sharp personnel, since removing unit's cover presents shock hazard.

• Using non-specified AC mains voltages may damage unit. Sharp is NOT responsible for damage from improper use.

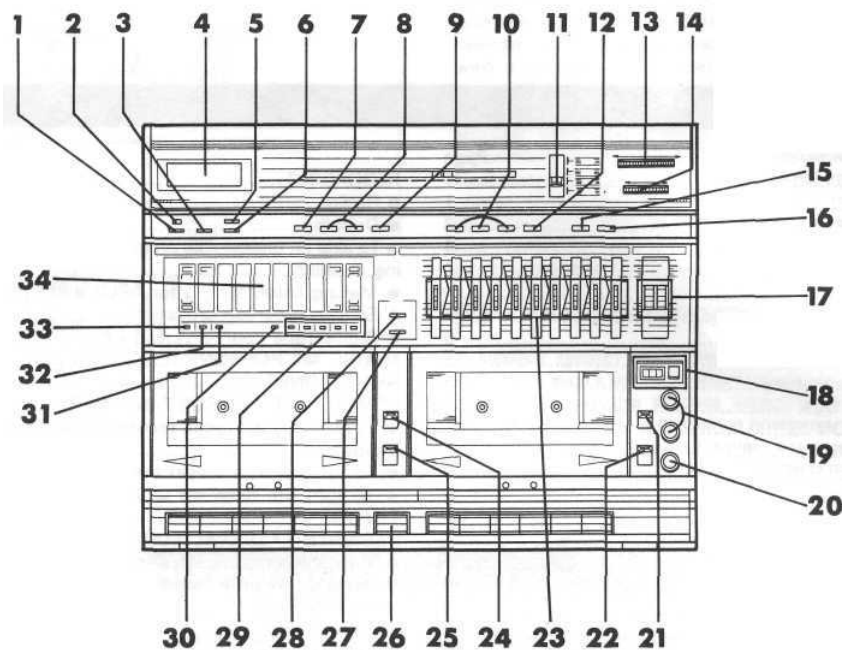

- | | | |
|---|--|--|
| 1. Hour/Sleep Off Button - HOUR/OFF | 13. Tuning Control - TUNING | 24. Tape 1) Direction Switch - DIRECTION |
| 2. Clock Adjust Button-CLOCK | 14. Fine Tuning Control - FINE TUNING | 25. Tape 1) Reverse Mode Switch - REV MODE |
| 3. Minute Button - MINUTE | 15. Timer On/Off Switch - TIMER | 26. Dubbing Start Button - DUBBING START |
| 4. Clock/Timer Display | 16. Power Switch -POWER | 27. APLD/APPS Clear Button - CLEAR |
| 5. Timer Adjust Button - TIMER | 17. Volume Controls - VOLUME | 28. APLD/APPS Set Button - SET |
| 6. Sleep On Button - SLEEP/ON | 18. Tape Counter and Reset Button - TAPE COUNTER | 29. APLD/APPS Set Indicators |
| 7. Tape 1) Tape Switch - TAPE 1 | 19. Microphone Sockets - MIC | 30. APPS End Pause Indicator - END PAUSE |
| 8. Tape 2) Tape Switches - TAPE 2 | 20. Headphones Socket - PHONES | 31. FM Stereo Indicator - FM ST |
| 9. Dubbing Switch - DUBBING SPEED | 21. Tape 2) Direction Switch - DIRECTION | 32. Sleep Indicator - SLEEP |
| 10. Function Switches - FUNCTION
(Do not press more than two FUNCTION switches at once.) | 22. Tape 2) Reverse Mode Switch - REV MODE | 33. Power Indicator - POWER |
| 11. Radio Band Selector - BAND SELECTOR | 23. Graphic Equalizer - GRAPHIC EQUALIZER | 34. Spectrum Analyzer - SPECTRUM ANALYZER |
| 12. FM Mode Switch - FM MODE | | |

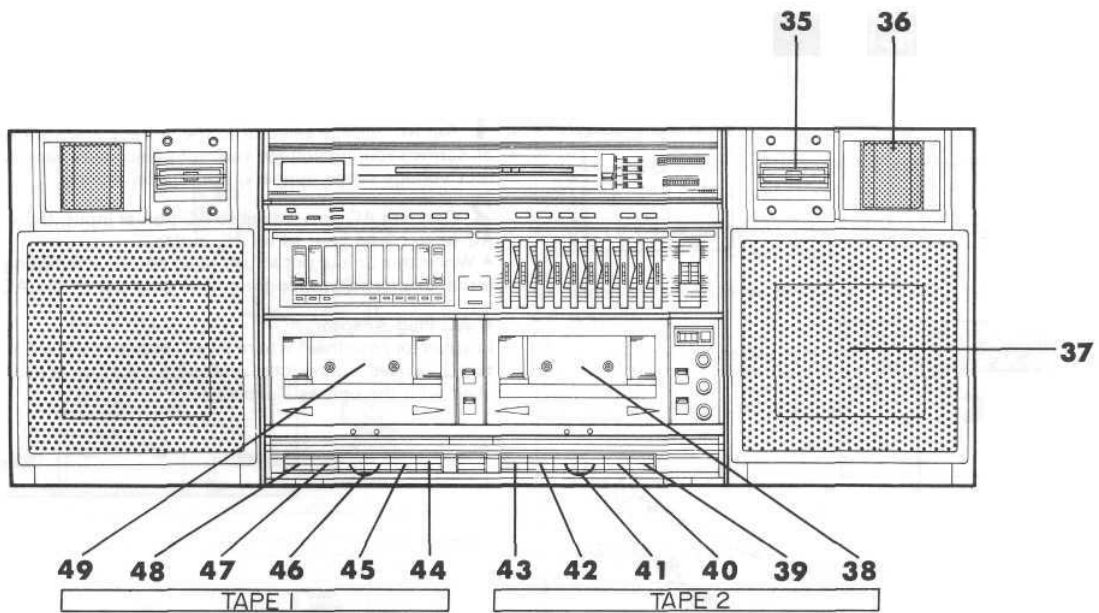

- | | | |
|-------------------|---|---|
| 35. Super Tweeter | 38. Cassette Compartment | 44. Pause Button - PAUSE II |
| 36. Tweeter | 39. Pause Button - PAUSE I I | 45. Stop/Eject Button - STOP/EJECT • |
| 37. Woofer | 40. Stop/Eject Button - STOP/EJECT • | 46. Fast Wind Buttons - ◀◀ FAST WIND ▶▶ |
| | 41. Fast Wind Buttons - ◀◀ FAST WIND ▶▶ | 47. Play Button - PLAY • |
| | 42. Play Button - PLAY • | 48. Play Button (Auto-Reverse continuing to TAPE 2) - ▶ |
| | 43. Record Button - RECORD • | 49. Cassette Compartment |

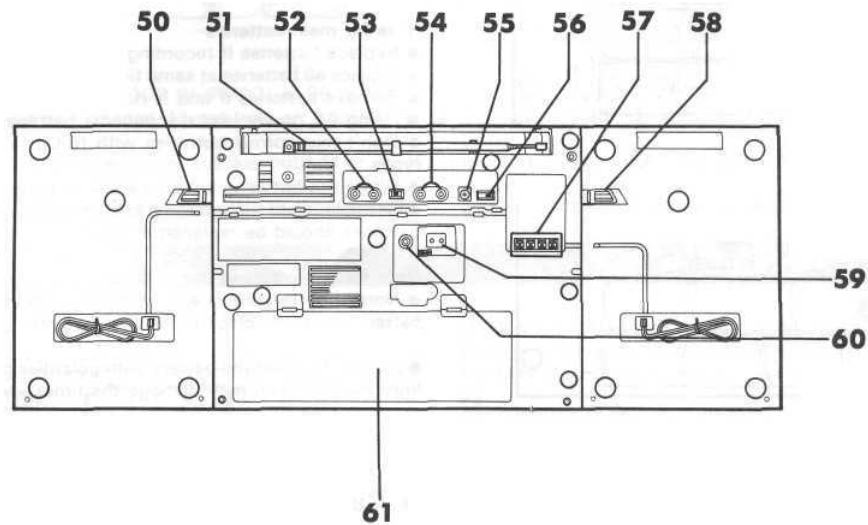

- | | | |
|---------------------------------------|---|--|
| 50. Speaker Release Lever | 54. Line Input Sockets | 58. Speaker Release Lever |
| 51. FM/SW1/SW2 Telescopic Rod Antenna | 55. Earth Terminal - GND (PHONO) | 59. AC Power Input |
| 52. Line Output Sockets - LINE OUT | 56. Beat Cancel Switch - BEAT CANCEL | 60. External DC Power Input - DC 15 V |
| 53. Input Selector - INPUT | 57. External Speaker Terminals - SPEAKERS | 61. Timer and Main Battery Compartment |

POWER SOURCE

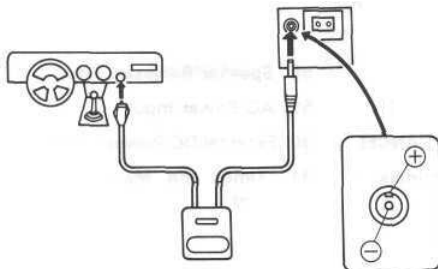
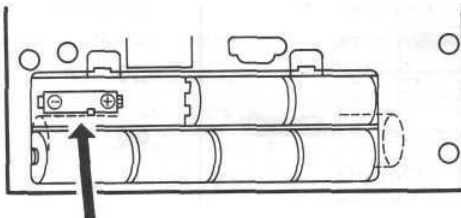
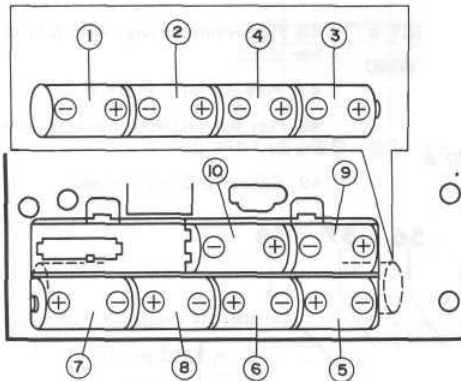
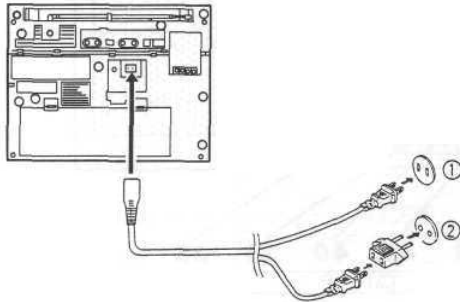

• AC Power

1 Set AC voltage selector to the voltage in your area. Loosen screw securing voltage selector panel, slide panel until correct voltage range appears, and tighten screw.

2 Connect AC power lead to AC power input, then connect AC power lead plug to an AC outlet.

• When this unit is not in use, also before attempting any internal examination, pull the mains plug out of the AC outlet.

• AC Plug Adaptor

In areas (or countries) where an AC outlet as shown in illustration ② is used, connect the unit using the AC plug adaptor supplied with the unit as illustrated.

• Battery Power

1 Remove AC power lead, and remove battery compartment cover.

2 Load 10 UM/SUM-1 or R 20 batteries into the main battery compartment and 1 UM/SUM-3 or R 6 battery into the timer battery compartment, observing the polarity shown on the rear panel and inside the battery compartment.

3 Replace battery compartment cover.

Note for main batteries

- Replace batteries if recordings start distorting.
- Replace all batteries at same time.
- Remove batteries if unit is not in use.
- Using AC power lead disconnects batteries.
- Don't mix normal batteries with Ni-Cd, alkaline, or other types.
- When the batteries become weak, recording may become impossible, even though radio broadcasts may be audible. All batteries should be replaced at once.

Note for timer battery

• Normal battery life is approximately one year. Replace the battery when the clock/timer display dims.

• Be sure to insert the battery with polarities properly aligned. Improper insertion may damage the timer and display.

Car Battery Power

This unit can be operated in cars with a DC 12V battery and a negative ground. For this purpose, use car battery adaptor (not supplied). The centre pin of the DC 1.5V socket is a negative polarity.

Attach the car battery adaptor as shown at left.

• Using car battery adaptor disconnects batteries.

SPEAKERS

Turn the POWER switch OFF/SLEEP before connecting the speakers.

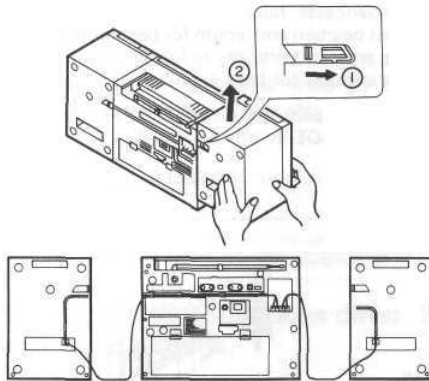
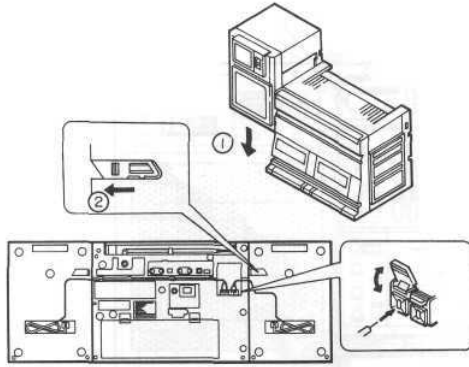

• Mounting the speakers

- 1 Align the channels on the speakers with the guides on the main unit.
- 2 Slide the speakers down into position until the tops of the speakers and main unit are flush.
- 3 Slide the release lever as shown in the illustration to lock the speaker.
- 4 Pull the speaker leads out enough to reach the SPEAKERS terminals. Connect the leads with the stripe to the (-) and the other leads to the (+) terminals. Fit the speaker leads into the channels in the speakers and main unit.

• Removing the speakers

- 1 Disconnect the leads from the SPEAKERS terminals.
- 2 Slide the release lever as shown in the illustration to unlock the speaker, and then pull the speakers up and off the main unit.
- 3 Pull the speaker leads out as far as necessary and connect them to the SPEAKERS terminals.

Caution

- Maximum speaker input is 100 W (PMPO) or 26 W (RMS). The speakers could be damaged if used with an amplifier producing greater than 100 W (PMPO) or 26 W (RMS).
- Do not short circuit the amplifier speaker outputs or speaker inputs as this could damage the amplifier and/or speakers.
- Speakers with less than 8 ohms impedance should not be used as the amplifier could be damaged.

SETTING THE CLOCK



1 While pressing the CLOCK button with a pencil tip or similar object, press the HOUR button to set the hour. Next press the MINUTE button to set the minutes.

2 Press the CLOCK button again to start the clock from the "00" second.

HOUR and MINUTE buttons

Press once to advance one digit. Hold depressed for more than two seconds to advance continuously.

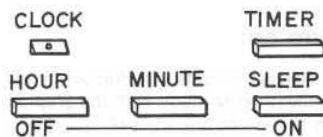

RADIO OPERATION

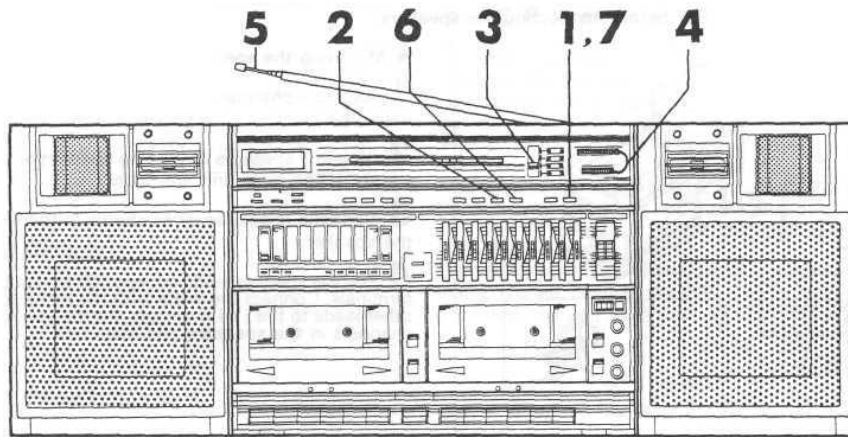

- 1 Turn the power switch on.
- 2 Set FUNCTION switch to RADIO.
- 3 Set BAND switch to FM, MW, SW1, or SW2.
- 4 Use TUNING control to tune the desired station.
The FINE TUNING control functions only for SW1 and SW2 bands.
- 5 For FM broadcasts, raise and extend telescopic rod antenna, then adjust position and length for best reception. For SW1 or SW2, raise antenna vertically to full height. For MW or SW 1, move and rotate unit for best sound.
- 6 Set FM MODE switch to STEREO for FM stereo; if sound is poor, set FM MODE switch to MONO.
- 7 Set POWER switch to OFF/SLEEP.

Aerial Adjustment Instructions

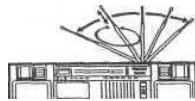

For Receiving FM Broadcasts
Raise and extend the telescopic rod antenna. Adjust the position and length of the antenna until FM broadcast reception is best.

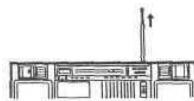

For Receiving SW1 or SW2 Broadcasts
Raise and extend the telescopic rod antenna vertically to its full length.

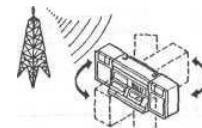

For Receiving MW Broadcasts
Rotate or locate the unit to receive peak signal strength of the MW broadcast.

SOUND CONTROL

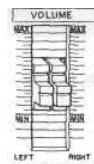

• Volume

Moving VOLUME controls (LEFT and RIGHT) towards MAX increases listening level, and MIN decreases level. The loudness circuit is activated when the volume is low to emphasize highs and lows.

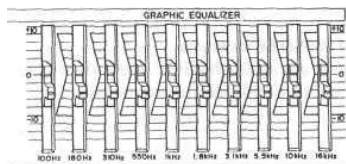

• Graphic equalizer

Moving a control for any frequency toward + 10 boosts level for that frequency, and -10 lowers level.

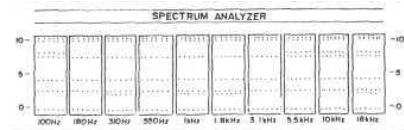

• Spectrum analyzer

The spectrum analyzer indicates the frequency band of the playback source. Adjustments made with the graphic equalizer will be reflected in the spectrum analyzer.

CASSETTE OPERATION

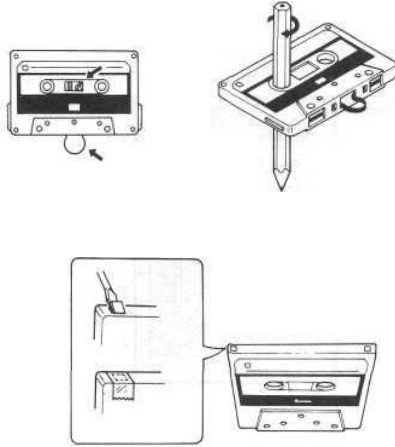

- Be sure to use quality tapes for best results.
- The use of tapes longer than C-90 (90 minutes) is not recommended.
- Before loading tape into cassette compartment, tighten slack tape with pen or pencil.
- Cassettes have removable tabs which allow recording to take place. Removing tab on top left protects side facing up from erasure. Cover tab holes with adhesive tape to erase or record again.
- TAPE 1: Playback only.
- TAPE 2: Playback or recording.

The following may occur due to the use of soft-touch controls. Note that these are not malfunctions.

(1) If PLAY is pressed and STOP/EJECT is then pressed while there is no power (AC cord is not connected, no batteries installed) and the power is then turned on and FAST WIND is pressed, the tape will momentarily advance at normal play-

back speed with audio output before fast-forwarding begins.
 (2) When battery power drops, the tape may not advance even if RECORD or PLAY is pressed. Also, the cassette compartment may not open when STOP/EJECT is pressed. Replace the batteries or use the AC cord.

TAPE 1 and TAPE 2 functions differ. Refer to the table below for proper use and differentiation of tape functions.

FUNCTION	TAPE 1	TAPE 2
Auto-reverse from A-B	Sides A-B are played continuously until STOP/EJECT is pressed when the REV MODE switch is at . Press the button to play sides A and B and then stop.	Sides A-B are played continuously until STOP/EJECT is pressed when the REV MODE switch is at .
Single side play	Possible when the REV MODE switch is at .	Possible when the REV MODE switch is at .
Switching sides A-B	Playback can be switched to either direction. • When is pressed for one-cycle auto reverse, playback will not proceed from side B to A.	Either side can be selected during playback; switching from B to A during recording is not possible.
APLD/APPS/APSS	Possible	Impossible
FAST WIND	Possible	Possible
Recording	Impossible	Recording and playback are possible.
Full Auto-Stop	All buttons are reset at the end of the tape in all modes except continuous auto reverse.	
Dubbing	Possible from TAPE 1 to TAPE 2 (High/Normal).	
Continuous Play	Combined auto-reverse is possible from TAPE 1 to TAPE 2.	

PLAYBACK

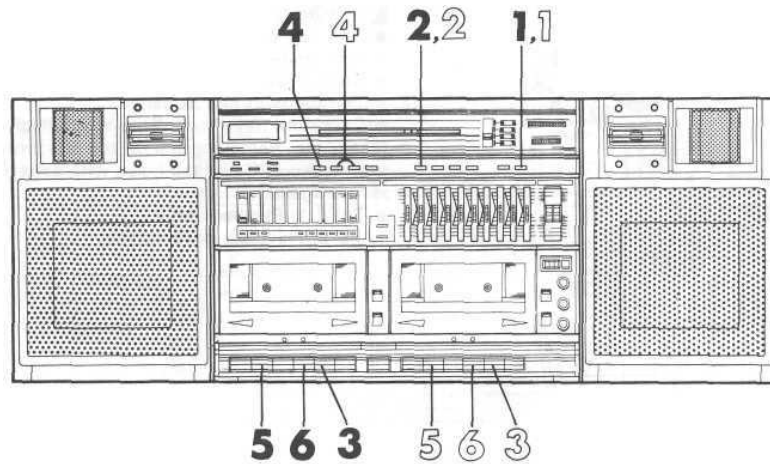

- When playing a tape on TAPE 1, set the DUBBING SPEED selector to NORMAL. The equalizer circuit for high speed dubbing will attenuate the high end when playing tapes with the DUBBING SPEED selector at HIGH.

- Playback always starts from side A when the tape is stopped.

- 1 Turn the power on.
- 2 Set FUNCTION switch to TAPE.
- 3 Press STOP/EJECT button and load cassette into TAPE 1 or 2 cassette compartment.
- 4 Set TAPE switches for TAPE 1 or 2 to the proper position.
 - Turn the METAL selector off when using normal or chrome tape in **TAPE 2**.
- 5 Press PLAY button of TAPE 1 or 2.

0 Advance tape to the place you want by pressing STOP/EJECT button first, then FAST WIND ►► button.

7 Press STOP/EJECT button, then PLAY button. If you went too far, press STOP/EJECT button, then FAST WIND ◀◀ button.

0 Repeat steps 6 and 7 until the desired selection is located. When you're finished, press STOP/EJECT button to stop and to eject tape. Replace tape in case.

Note:

While fast winding operation is in progress, the FAST WIND button will not be released when the tape end is reached if the PAUSE button is pressed. In this case, press the STOP/EJECT button.

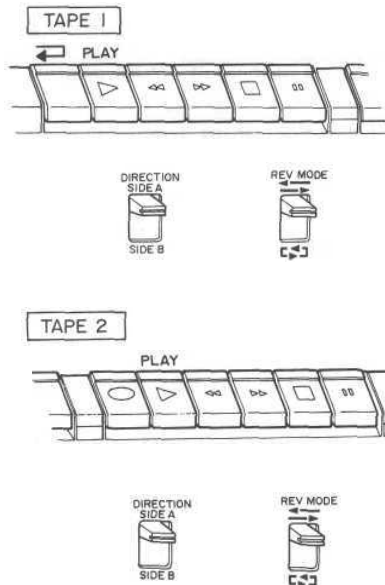

• Auto reverse

- Also functions for recording.

1 TAPE 1

Press and lower the REV MODE switch for one-cycle auto reverse.

Press PLAY and lower the REV MODE switch for continuous auto reverse.

For one-way playback, lift the REV MODE switch.

Press DIRECTION to select side B, and press it again for side A. In one cycle auto reverse, and PLAY will pop up after one cycle is completed. If listening to side B, side A cannot be played by resetting the DIRECTION selector (the tape will stop if DIRECTION is set to A).

2 TAPE 2

Press PLAY and lift the REV MODE switch for one-way playback.

Press PLAY and then lower the REV MODE switch for continuous auto reverse.

Press DIRECTION to select side B, and press it again for side A.

• Continuous playback

- 1 Press $\overrightarrow{\text{P}}$ for TAPE 1. This also engages the PLAY button.
 - 2 Press PLAY button of TAPE 2.
- O Auto reverse and continuous playback can combine.

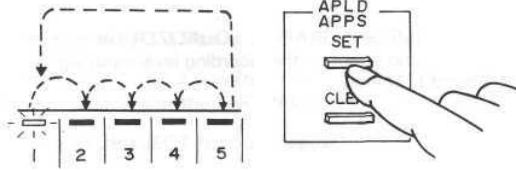

- Playback of TAPE 2 will begin automatically if TAPE 1 is played through side A and to the end of side B.
- The audio of both tapes can be mixed by pressing the PLAY button of TAPE 1 while listening to TAPE 2.
- Pressing the $\overrightarrow{\text{P}}$ button of TAPE 1 will not set the continuous play mode if TAPE 2 playback is already in progress.

• APLD/APPS/APSS (TAPE 1 only)

APLD locates a desired selection by skipping the number of pieces from the current to the desired selection.

APPS plays a specified number of selections and automatically enters the pause mode.

APSS locates the beginning of the current or next selection and automatically begins playback from that piece.

- APPS and APLD can locate a maximum of five intervals. To automatically locate a selection more than five away, move to selection five and then reactive APPS/APLD for the number of remaining intervals.

- The APPS/APLD setting can be changed while either is functioning.

Automatic Program Locate Device (APLD)

1 Count the number of gaps between the current selection and the desired selection. Press SET the same number of times. The APLD/APPS indicator will light.

- Enter the APLD number only to skip more than one selection.

2 If TAPE 1 is not in the playback mode, press PLAY.

3 During side A playback, press FAST WIND $\overrightarrow{\text{P}}$ to search forward, or FAST WIND $\overleftarrow{\text{P}}$ to search back. During side B playback, press FAST WIND $\overleftarrow{\text{P}}$ to search forward, or FAST WIND $\overrightarrow{\text{P}}$ to search back.

4 Press CLEAR to cancel APLD in progress. The deck will return to the playback mode.

5 When TAPE 1 reaches the desired space between selections, FAST WIND $\overleftarrow{\text{P}}$ or $\overrightarrow{\text{P}}$ will be released and playback will resume.

- To change the direction of APLD search, press STOP/EJECT to stop the tape and cancel all settings, and then repeat the above procedure.

Auto Program Pause System (APPS)

1 Press PLAY on TAPE 1 to begin playback.

2 Count the number of selections to be played back. Press SET the same number of times. The appropriate APLD/APPS indicator will light.

The indicators will always show the number of selections remaining to be played during playback.

3 When the last selection ends, the tape will stop and the END PAUSE indicator will light. PLAY will not be released.

4 Press CLEAR to release the END PAUSE function. TAPE 1 and 2 will not function when END PAUSE is on.

To eject the tape or perform other operations after the APPS operation is completed, press STOP/EJECT for TAPE 1 to cancel the APPS mode.

Auto Program Search System (APSS)

- First press PLAY.

To Listen to the Current Selection Again (Rewind APSS)

Side A: Press FAST WIND $\overleftarrow{\text{P}}$.

Side B: Press FAST WIND $\overrightarrow{\text{P}}$.

To Listen to the Next Selection (FF APSS)

Side A: Press FAST WIND $\overrightarrow{\text{P}}$.

Side B: Press FAST WIND $\overleftarrow{\text{P}}$.

- Playback will begin when the beginning of the current or next selection is located.

If the APLD/APPS/APSS Does Not Function Normally

APPS

- Do not leave the APPS engaged for extended periods as it may damage the tape or pinch roller. Press the STOP/EJECT to release PLAY button.

- Both decks will stop during simultaneous playback or when dubbing from TAPE 1 to 2 if APPS is activated.

- APPS may not detect the "end" of a selection if the recording level is very low or the music fades.

APLD and APPS

- If APLD/APPS is activated near the end of a selection, the following selection may be skipped. Watch the indicator to confirm.

- Do not change the tape transport mode during APLD/APSS operation. The APLD/APSS mode will be cancelled and playback will begin from the other side of the tape.

APLD, APPS and APSS

These features may not function normally with the following tapes.

- Tapes containing conversation or other material with long pauses.
- Tapes with a low recording level.
- When the pause between pieces is less than 4 sec.
- Music containing extended quiet passages or parts which are not recorded.
- Tapes containing excessive noise or material recorded from hum radio broadcasts.

- Cue and review (Possible only on TAPE 2)

CUE and REVIEW can be used when fast forwarding or rewinding through short sections of the tape. CUE and REVIEW can only be used during playback on TAPE 2.

CUE

Press the FAST WIND button corresponding to the direction of tape playback.

RECORDING

- When recording important selections, be sure to make a preliminary test to ensure that the desired material is being properly recorded.
- The ALC (Automatic Record Level Control) circuit automatically controls the level of input signal strength used for recording.

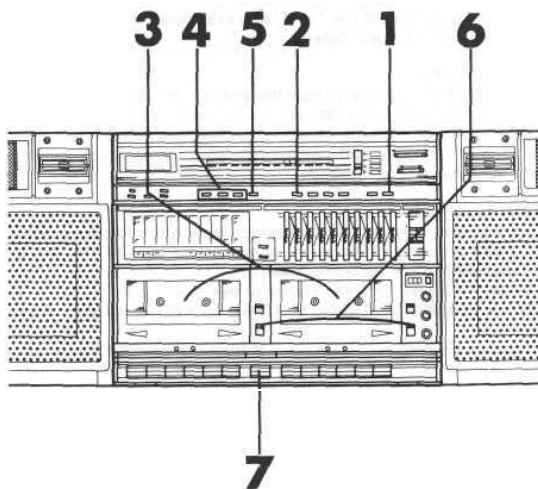
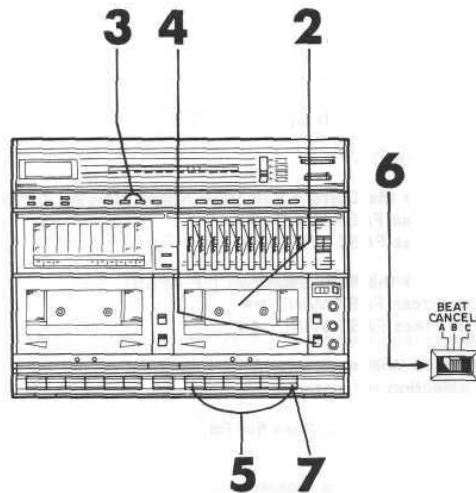

REVIEW

Press the FAST WIND button opposite to the direction of tape playback.

- CUE and REVIEW will continue as long as the FAST WIND button is pressed. Release the FAST WIND button to resume normal playback.

- The VOLUME and GRAPHIC EQUALIZER controls may be adjusted with no effect on the recording level input signal. (Variable Sound Monitor)

- Radio

- 1 Tune in desired station. (See page 6.)
- 2 Load cassette into TAPE 2 cassette compartment.
- 3 Set TAPE switches for TAPE 2 to the proper position.
 - Turn the METAL selector off when using normal or chrome tape in TAPE 2.
- 4 Set the REV MODE switch to when recording continuously from side A to B. Set it to when recording only one side.
- 5 Press PAUSE button, then RECORD button, which also engages PLAY button.
- 6 Set the BEAT CANCEL switch on the rear panel to A, B, or C (whichever gives the best reception) when recording MW, SW1 or SW2.
- 7 Press PAUSE button again to begin recording.

- Dubbing

- 1 Turn the power switch on.
- 2 Set FUNCTION switch to TAPE.
- 3 Load recorded cassette into cassette compartment of TAPE 1. Insert the blank tape into TAPE 2.
- 4 Set TAPE switches for TAPE 1 and 2 to the proper positions.
 - Turn the METAL selector off when using normal or chrome tape in TAPE 2.
- 5 Set DUBBING SPEED switch to NORMAL for equivalent-speed dubbing, HIGH for double-speed dubbing.
- 6 Set the REV MODE switch to when dubbing continuously from side A to B. Set it to when dubbing only one side.
- 7 Press DUBBING START. The PLAY button of Tape 1, PLAY and RECORD buttons of TAPE 2 will be automatically engaged.
 - Do not change the setting of the DUBBING SPEED switch during dubbing.
 - Do not connect any plug to the MIC socket during dubbing.

• To Skip an Undesirable Programme with APLD and APPS During Dubbing

Certain materials can be dubbed with the APLD or APPS function for quick location of desired selections.

- 1 Perform steps 1 through 6 under DUBBING.
- 2 Use the APLD feature to locate the beginning of the desired selection. (See page 9.)
- 3 Press SET to input the number of selections to be dubbed. (See page 9 under APPS.)
- 4 Press DUBBING START.
- 5 Both TAPE 1 and 2 will stop after dubbing the number of preset selections and the END PAUSE indicator will light.
- 6 Press STOP/EJECT for both tapes.
- 7 To perform dubbing of subsequent selections, repeat steps 1 through 6.

• Erasing Recorded Tapes

Previously recorded material will be erased automatically whenever new material is re-recorded onto the tape. If it is desired to erase a previously recorded tape without recording over it, follow the instructions.

- 1 Insert the tape to be erased into the cassette compartment of TAPE 2.
- 2 Set the FUNCTION switch to TAPE.
- 3 Set the DUBBING switch to HIGH.
- 4 Make sure TAPE 1 is stopped and depress the RECORD button. This will automatically engage the PLAY button and begin erasing the tape.

MIXING MICROPHONE

- 1 Be sure your microphone has a 6.3 mm (1/4") diameter plug and 400 ohms to 3 kohms impedance.
- 2 Connect microphone plug to L/MIC socket.
 - Connect a microphone to both left and right inputs to record in stereo.
- 3 Set DUBBING switch to NORMAL.
 - Mixing is not possible at HIGH.

HEADPHONES

- 1 Be sure your headphones have a 6.3 mm (1/4") diameter plug and 8 to 32 ohms impedance.

• Making Blank Spaces for APLD and APPS

Blanks of at least 4 seconds are required for APLD and APPS to function. Follow the procedure below to enter these blanks in your own recordings.

- Make sure TAPE 1 is not running.
- 1 Press PAUSE on Tape 2 at the end of a recording selection.
 - 2 Set the FUNCTION selector to TAPE.
- Disconnect any microphones.
- 3 Press PAUSE again on Tape 2 and run the tape without recording for about 5 seconds.
 - 4 Press PAUSE again on Tape 2 to stop the tape. The required blank is now on the tape.
 - 5 Resume recording as before.
- Simply repeat the above procedure for all other APLD/APPS blanks.
 - If dubbing from TAPE 1 to TAPE 2, simply pause TAPE 1 and continue running TAPE 2 for 5 seconds to leave the blank.

• Digital Tape Counter (only Tape 2)

Push the button at the side of the counter to reset to "000". The counter will advance while recording or playback is in progress. These readings provide a useful reference during recording and playback.

- 4 Play the radio, TAPE 1, or an external audio unit.
- 5 Record as described in Radio. (See page 10.)
 - Place microphone about 10 - 15 cm (4 - 6") away from source.
 - If howling occurs, lower volume or remove microphone as far as possible from speakers.If the microphones howl during recording, the ALC circuit will momentarily decrease the microphone level.

- Connect headphones plug to PHONES socket, which disconnects speakers. Adjust volume by using VOLUME controls.

HOW TO USE THE BUILT-IN TIMER

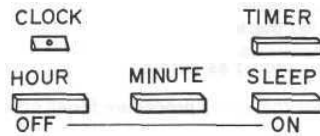
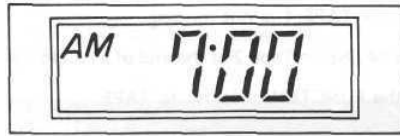

• Listening to the radio, recording radio programmes, playing a cassette

To record or playback a tape, first load a tape into the cassette compartment. To listen to the radio, turn the power on and tune in the desired station.

Note:

The tape deck and radio are not turned off even if POWER is set to OFF when the sleep timer or automatic ON timer is set.

1 Press TIMER button. The lower dot in the colon between the hour and minutes in the clock will go out.

2 While pressing TIMER button, press HOUR and MINUTE to set the desired time.

3 Set TIMER switch to ON. ☐ will appear on the display.

4 Set POWER to OFF.

The radio will come on automatically by completing step 4.

5 To record radio programmes

Press RECORD.

To playback a cassette

Press PLAY on either TAPE 1 or 2.

6 Once step 5 is completed, the tape deck will be automatically activated at the preset time to either record or playback.

7 The radio or tape deck is turned off automatically 64 minutes after started by the timer.

• To turn the unit off, simply set the TIMER switch to OFF. The timer will not be activated again unless it is reset once it is turned off. If using the cassette deck, first press STOP/EJECT, and then turn the timer off.

• Set the TIMER to ON for use as a wake-up timer for the next day. (The timer is not cancelled even if the unit turns off automatically after 64 minutes.)

• The power will be cut off and playback will stop after 64 minutes but the PLAY button will not be released. Press STOP/EJECT.

This is also true when using the sleep function.

• To turn off at a preset time less than 64 minutes

• The radio and cassette deck can all be turned off automatically.

• The timer can be set whether or not other functions are being used.

1 Press SLEEP. The upper dot in the colon between the hour and minutes in the clock will go out, and the SLEEP indicator will light.

2 While pressing SLEEP button, press MINUTE to set the desired time.

• The time setting decreases one minute each time MINUTE is pressed.

• Hold MINUTE pressed to quickly decrease the time setting.

• Skip this step if the desired time setting is 64 minutes.

3 Set POWER to OFF/SLEEP.

The unit will turn off after the preset time.

Simply press SLEEP to reset the 64 minute time setting after the unit turns off automatically.

• Press SLEEP to display the remaining time when the SLEEP feature is on.

• Press SLEEP and HOUR/OFF to cancel the SLEEP feature and reset the time display to "00" during SLEEP mode operation.

• To turn the radio off with SLEEP and on again with the TIMER

1 Set the TIMER as described in steps 1 - 4 under TIMER.

2 Set the SLEEP timer as described above.

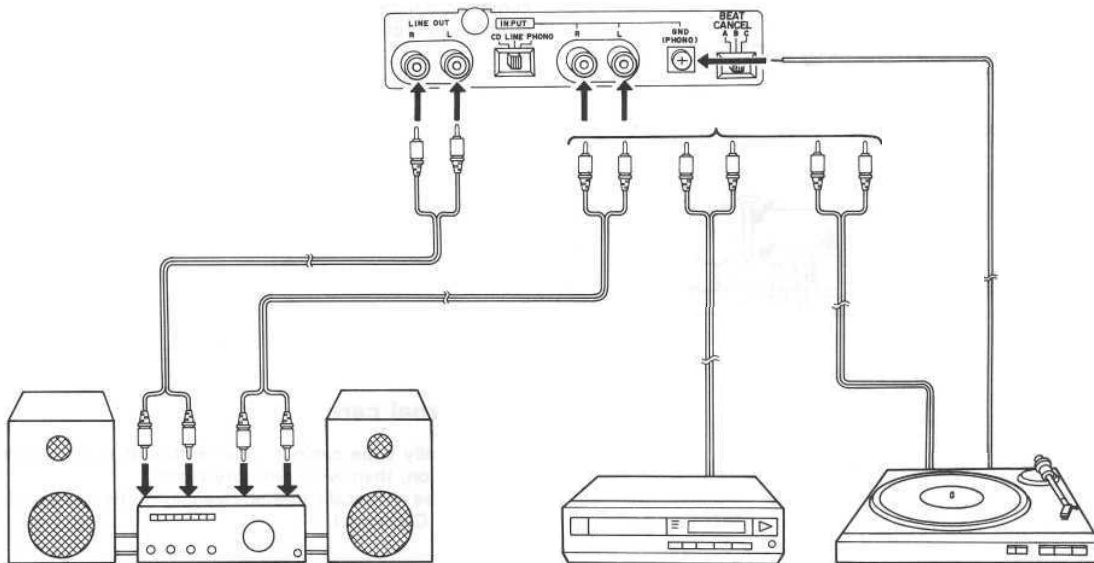

- Turn the power off before connecting or disconnecting any other component.

- **Turntable or Compact Disc player**

- 1 Make sure the turntable uses a magnetic cartridge. Connect the turntable or CD player outputs to the INPUT sockets of the unit. If the turntable has a ground, connect it to GND.

- 2 Set the INPUT selector on the rear panel to the proper position. (CD or PHONO)

- 3 Set the FUNCTION switch to PHONO/CD/LINE.

- 4 Start the record or set the CD player to PLAY.

To record

Follow the instructions for recording on page 10.

- **Using an External Amplifier**

Audio output

- 1 Connect the LINE IN terminals of your amplifier to the LINE OUT sockets of the unit.

- 2 Select the desired features on your amplifier.

- 3 Adjust the volume using the volume control of the external amplifier.

Recording From Another Amplifier

- 1 Connect the LINE OUTPUT terminals of your amplifier to the INPUT sockets of the unit.

- 2 Set the INPUT selector on the rear panel to LINE.

- 3 Set the FUNCTION switch to PHONO/CD/LINE.

- 4 Start recording as usual. (See page 10.)

MAINTENANCE

TAPE 1

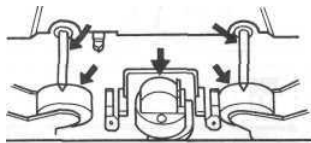

TAPE 2

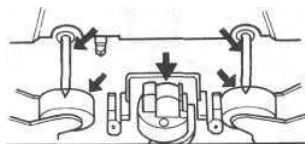

• Internal care

- Dirty heads, capstans and pinch rollers cause poor sound and tape jams. Clean these parts with cotton swab moistened with commercial head/pinch roller cleaner or isopropyl alcohol.
- After long use, the deck's heads and capstans will become magnetised, which causes poor sound. Demagnetise these parts once every 30 hours of playing/recording time by using commercial tape deck demagnetiser. Read demagnetiser's instructions carefully before using.

• External care

- Periodically wipe cabinet clean with soft cloth and dilute soap solution, then wipe with dry cloth.
- Do not use chemically treated cleaning cloths or other chemicals. (See Cautions.)

SPECIFICATIONS

The manufacturer reserves the right to vary specifications, design, or use alternative materials as may be deemed necessary or desirable at any time, any such changes or variations being of a kind as not to reduce the quality, performance or appearance.

GENERAL

Power source:	AC 110 -127 V and 220 - 240 V, 50/60 Hz DC 15V(UM/SUM-1 or R20 type x 10, or external 15 V DC)
Output power:	PMPO; 200 W (100 W + 100 W) (AC operation) MPO; 40 W (20 W + 20 W) (AC operation) RMS; 26 W (13 W + 13 W) (DC operation, 10% distortion)
Input impedance:	External mic; 600 ohms Phono/line in/CD; 50 kohms
Loaded impedance:	Headphones; 8 - 32 ohms External speakers; 8 - 16 ohms Line out; 0.6 V/50 kohms
Dimensions:	Width; 680 mm Height; 250 mm Depth; 180 mm
Weight:	9.3 kg without batteries

TAPE RECORDER

Tape:	Compact cassette tape
Frequency response:	30 - 15,000 Hz (normal tape) 30 - 16,000 Hz (CrO2 tape) 30 - 17,000 Hz (metal tape)
Signal/noise ratio:	55 dB (Tape 1, playback) 50 dB (Tape 2, recording)

RADIO

Frequency range:	MW; 526.5 - 1606.5 kHz SW1; 2.3 - 7.3 MHz SW2; 7.3 - 22 MHz FM; 64 - 74 MHz
-------------------------	--

SPEAKER

Speakers:	210 cm ² square-type flat diaphragm woofer x 2 5 cm tweeter x 2 Super tweeter x 2
Impedance:	8 ohms
Input:	26 W (RMS) 100 W (PMPO)

MEMO

MEMORANDUM FOR THE RECORD
SUBJECT: [Illegible]



Sharp
[Illegible]

SHARP

SHARP CORPORATION

TINSZ0999AFZZ

Printed in Japan
B8801-6MH.KB